



# HI LIFT CRANES

## MK 88 mobile construction crane

Biggest and strongest 4-axle crane on the market



Highest hook height: **59.1 m** // Maximum radius: **45.0 m**

Maximum lifting capacity at the jib head: **2200 kg**

High erection curve // Luffed positions: **15°, 30° and 45°**

**Can be erected by only one man in 11 minutes** (after being raised onto its supports)

**LIEBHERR**

# Crane operation

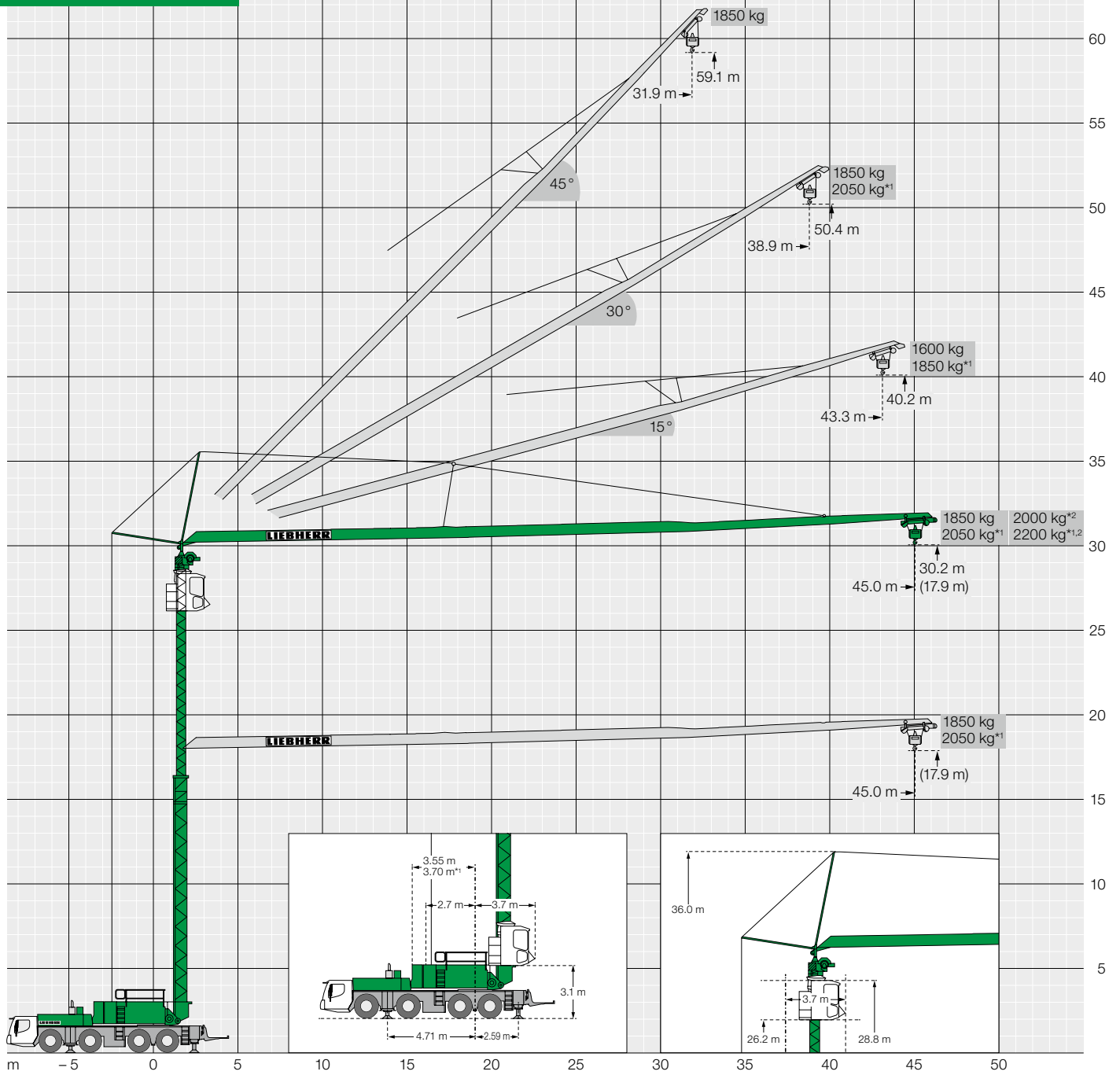

# Transport

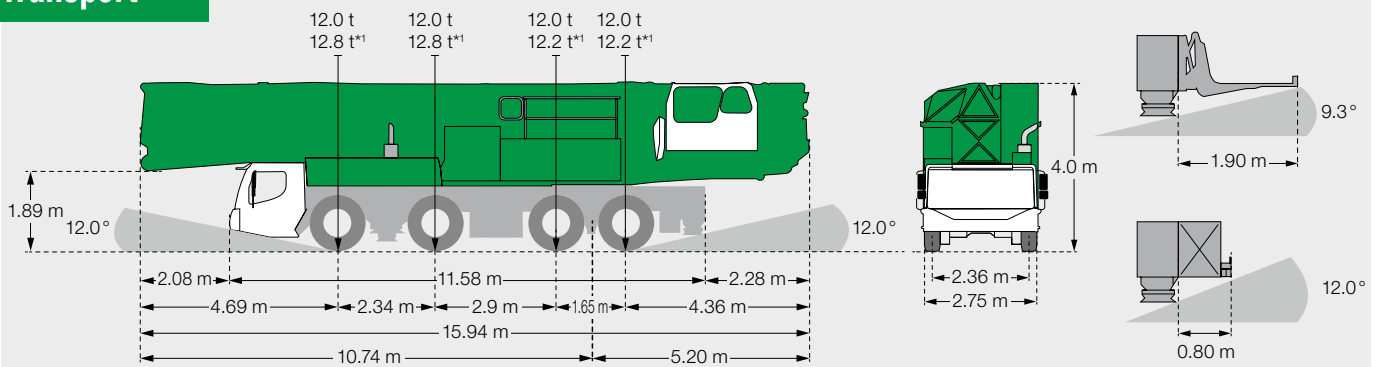

# Plan view

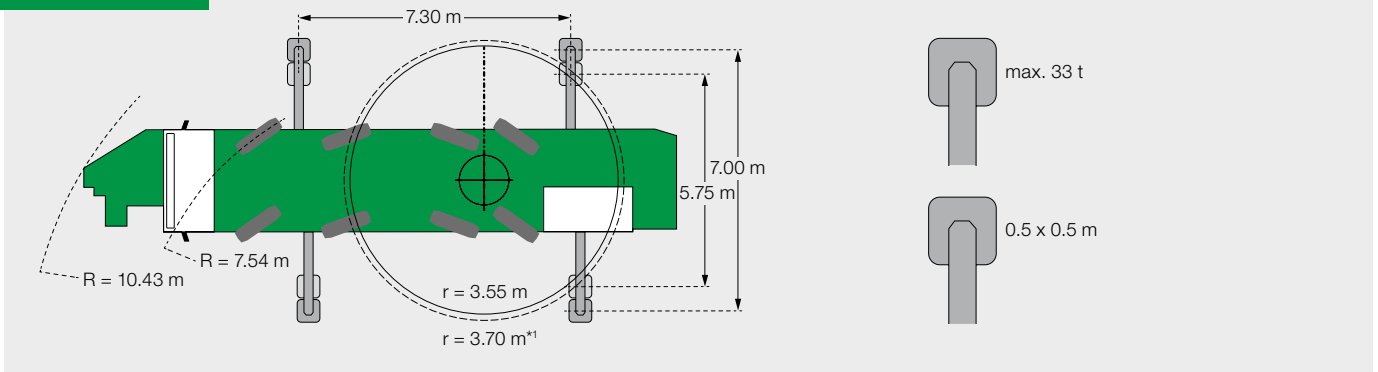

## MK 88 Plus, with additional ballast\*1

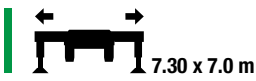
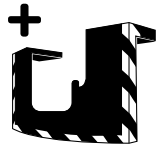

				m																			
		m	kg	10.0	12.0	14.0	16.0	18.0	20.0	22.0	24.0	26.0	28.0	30.0	32.0	34.0	36.0	38.0	40.0	42.0	44.0	45.0	
0°	45.0		3.3 – 12.0	8000	8000	8000	6900	6070	5410	4870	4420	4050	3730	3450	3210	2990	2800	2630	2480	2340	2220	2100	2050
			3.3 – 11.0	8000	8000	7370	6360	5580	4960	4460	4050	3700	3400	3140	2920	2720	2540	2390	2250	2120	2000	1900	1850
	Plus*2		3.3 – 13.0	8000	8000	8000	7490	6600	5900	5320	4840	4440	4090	3790	3530	3300	3090	2920	2760	2600	2440	2280	2200
15°	43.3		3.2 – 40.0		1850																1700*3		
			3.2 – 35.0		1850														1400*3				
30°	38.9		3.0 – 11.0		6000	5650	5050	4560	4150	3810	3510	3250	3030	2830	2650	2490	2350	2220	2050				
			3.0 – 9.0		5620	4970	4450	4020	3660	3360	3100	2870	2670	2490	2340	2200	2070	1950	1800				
45°	31.9		2.7 – 31.9		1850																		
			2.7 – 31.9		1850																		

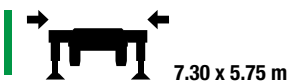

				m																			
		m	kg	10.0	12.0	14.0	16.0	18.0	20.0	22.0	24.0	26.0	28.0	30.0	32.0	34.0	36.0	38.0	40.0	42.0	44.0	45.0	
0°	45.0		3.3 – 10.5	8000	8000	6930	5870	5080	4470	3980	3580	3250	2970	2730	2520	2340	2180	2030	1910	1790	1690	1590	1550
			3.3 – 9.5	8000	7590	6310	5380	4680	4130	3690	3320	3020	2760	2540	2350	2180	2030	1900	1780	1680	1580	1490	1450
15°	43.3		3.2 – 34.0	1850	1850												1450*3						
			3.2 – 29.0	1850	1850										1150*3								
30°	38.9		3.0 – 11.0	6000	6000	5580	4880	4320	3880	3510	3200	2930	2700	2500	2330	2180	2040	1910	1750				
			3.0 – 9.0	6000	5480	4650	4030	3540	3150	2830	2570	2340	2150	1980	1830	1700	1590	1490	1350				
45°	31.9		2.7 – 31.9	1850	1850																		
			2.7 – 24.0	1850	1850										1350*3								

= max. 6.5 Bft (14.0 m/sec)    = max. 8.0 Bft (20.0 m/sec)

\*1 Lifting capacities with 2.0 t additional ballast

\*2 Lifting capacities with Plus package

\*3 Lifting capacity details at maximum erection height, higher lifting capacities are possible with lower erection heights. See the operating manual for more details.

## Comparison with mobile cranes

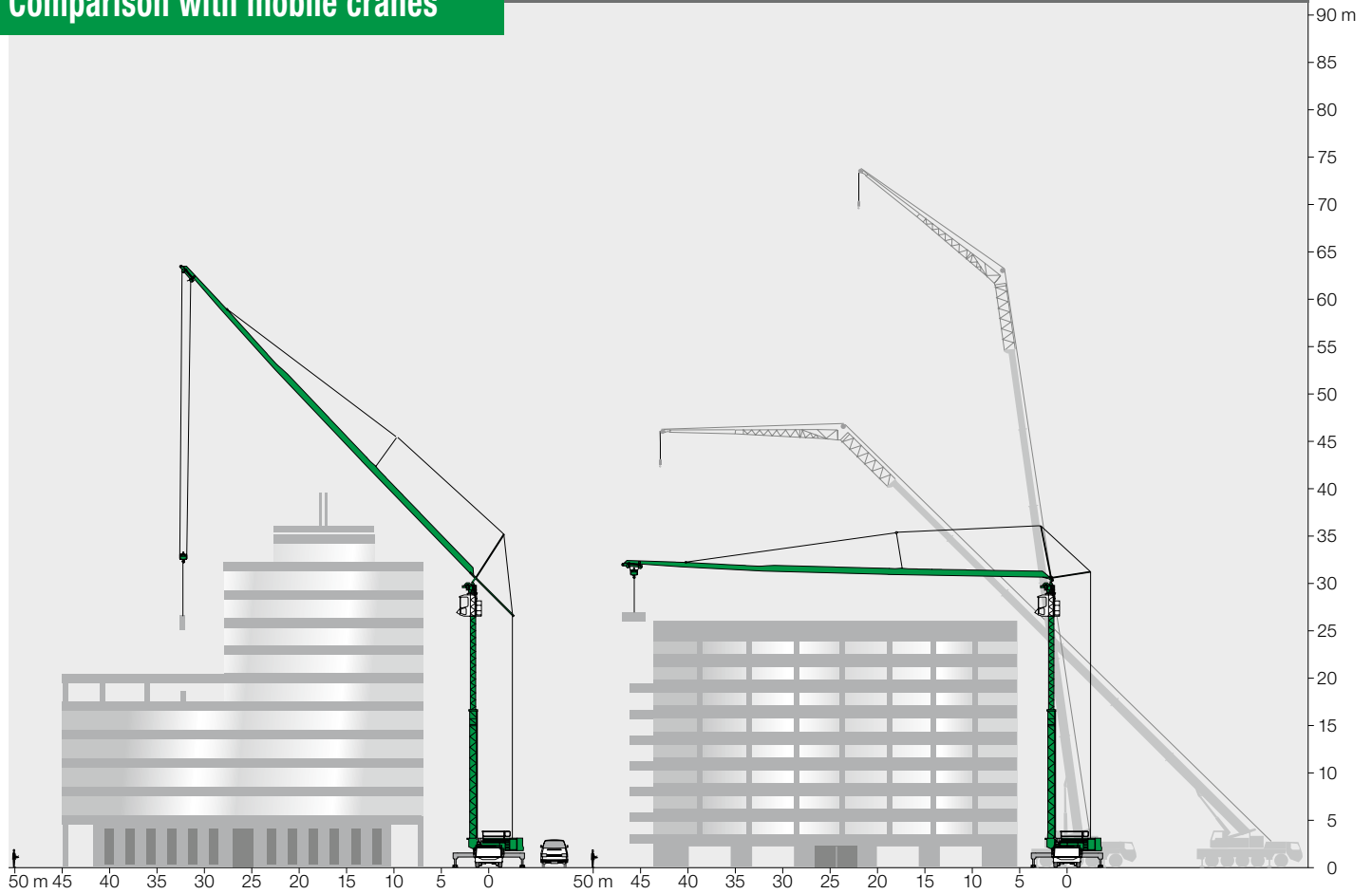

## Erection curve

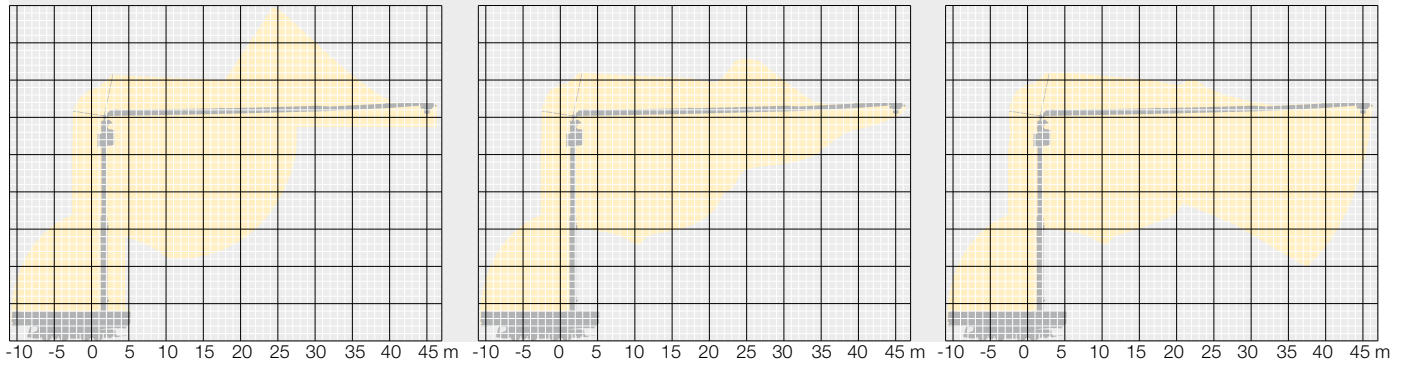

**HI LIFT  
CRANES**

### Hi Lift Cranes

11 Kellow Place, Wiri  
Auckland 2104

Telephone: 09 262 1387  
sales@hilift.co.nz  
www.hilift.co.nz