



Grove GMK4100L

Product Guide



-  100 t
-  60 m
-  10 - 22 m
-  85 m

**All-Terrain Crane • AT-Kran
Grue Automotrice Routière
Grúa Todo Terreno Rapida • Gru Fuoristrada Veloci
Вездеходный подъемный кран**

Load charts • Traglasten • Capacités de levage Capacidades • Capacità • Таблицы грузоподъемности

Telescopic boom • Teleskopausleger • Flèche principale • Pluma telescópica • Braccio telescopico • Телескопическая стрела



11,65 - 60,0 m



7,0 m



360°



26,1 t



EN 13000

m	11,65°	11,65	15,90	20,11	24,26	28,25	32,11	35,83	40,08	44,29	48,43	52,43	56,28	60,00
2,5	100,0	-	-	-	-	-	-	-	-	-	-	-	-	-
3,0	69,0	69,5	63,5	59,0	56,0	-	-	-	-	-	-	-	-	-
4,0	59,0	58,5	56,0	52,5	49,5	47,0	-	-	-	-	-	-	-	-
5,0	52,0	50,0	49,5	47,0	44,5	41,5	37,5	30,0	-	-	-	-	-	-
6,0	46,0	43,5	44,0	41,5	40,5	38,0	36,5	30,0	23,0	-	-	-	-	-
7,0	41,0	38,0	38,5	37,5	36,5	35,0	33,5	30,0	23,0	18,0	-	-	-	-
8,0	36,0	34,0	34,5	34,0	33,0	32,0	31,0	29,5	23,0	18,0	14,3	-	-	-
9,0	30,0	30,0	31,0	31,0	30,0	29,5	28,5	28,0	22,5	18,0	14,3	11,6	-	-
10,0	-	-	28,0	28,5	27,5	27,5	26,0	26,0	21,5	18,0	14,3	11,6	9,5	-
11,0	-	-	25,5	25,5	25,5	25,5	24,0	24,0	20,5	17,7	14,3	11,6	9,5	8,0
12,0	-	-	22,5	23,0	22,5	23,0	21,5	21,5	19,1	17,0	14,3	11,6	9,5	8,0
13,0	-	-	19,7	20,0	19,8	20,5	19,7	19,3	17,9	16,2	14,2	11,6	9,5	8,0
14,0	-	-	-	17,7	18,3	18,1	18,6	17,5	16,4	15,3	14,0	11,6	9,5	8,0
15,0	-	-	-	16,4	16,5	16,2	16,8	15,9	14,9	14,4	13,3	11,5	9,5	8,0
16,0	-	-	-	14,8	14,8	14,8	15,2	14,6	13,6	13,1	12,6	11,3	9,5	8,0
18,0	-	-	-	-	12,2	12,8	12,5	12,0	12,4	11,0	10,8	10,6	9,5	8,0
20,0	-	-	-	-	10,8	10,8	10,5	10,4	10,5	9,3	9,2	9,2	9,0	8,0
22,0	-	-	-	-	-	9,2	8,9	9,4	8,9	7,9	7,8	7,9	8,0	7,7
24,0	-	-	-	-	-	8,0	8,2	8,1	7,6	6,6	7,1	6,9	7,1	7,1
26,0	-	-	-	-	-	-	7,4	7,0	6,5	6,0	6,6	6,3	6,4	6,2
28,0	-	-	-	-	-	-	6,5	6,1	5,6	5,3	6,0	5,6	5,7	5,4
30,0	-	-	-	-	-	-	-	5,4	4,9	5,0	5,3	5,2	5,1	4,7
32,0	-	-	-	-	-	-	-	4,7	4,2	4,6	4,6	4,6	4,4	4,1
34,0	-	-	-	-	-	-	-	-	3,9	4,4	4,1	4,1	3,9	3,5
36,0	-	-	-	-	-	-	-	-	3,2	4,0	3,8	3,6	3,4	3,0
38,0	-	-	-	-	-	-	-	-	-	3,5	3,4	3,2	2,9	2,6
40,0	-	-	-	-	-	-	-	-	-	3,1	3,0	2,8	2,5	2,2
42,0	-	-	-	-	-	-	-	-	-	-	2,7	2,4	2,2	1,8
44,0	-	-	-	-	-	-	-	-	-	-	2,4	2,1	1,8	1,5
46,0	-	-	-	-	-	-	-	-	-	-	-	1,8	1,5	1,2
48,0	-	-	-	-	-	-	-	-	-	-	-	1,6	1,3	0,9
50,0	-	-	-	-	-	-	-	-	-	-	-	-	1,0	-

* 0° over rear, nach hinten, en arrière, por la parte trasera, sul posteriore, Над задней частью

Load charts • Traglasten • Capacités de levage Capacidades • Capacità • Таблицы грузоподъемности

Working range - Arbeitsbereiche • Diagramme de levage - Gama de trabajo - Area di lavoro - Грузовысотные характеристики

 11,65 - 60,00 m

 7,0 m

 360°

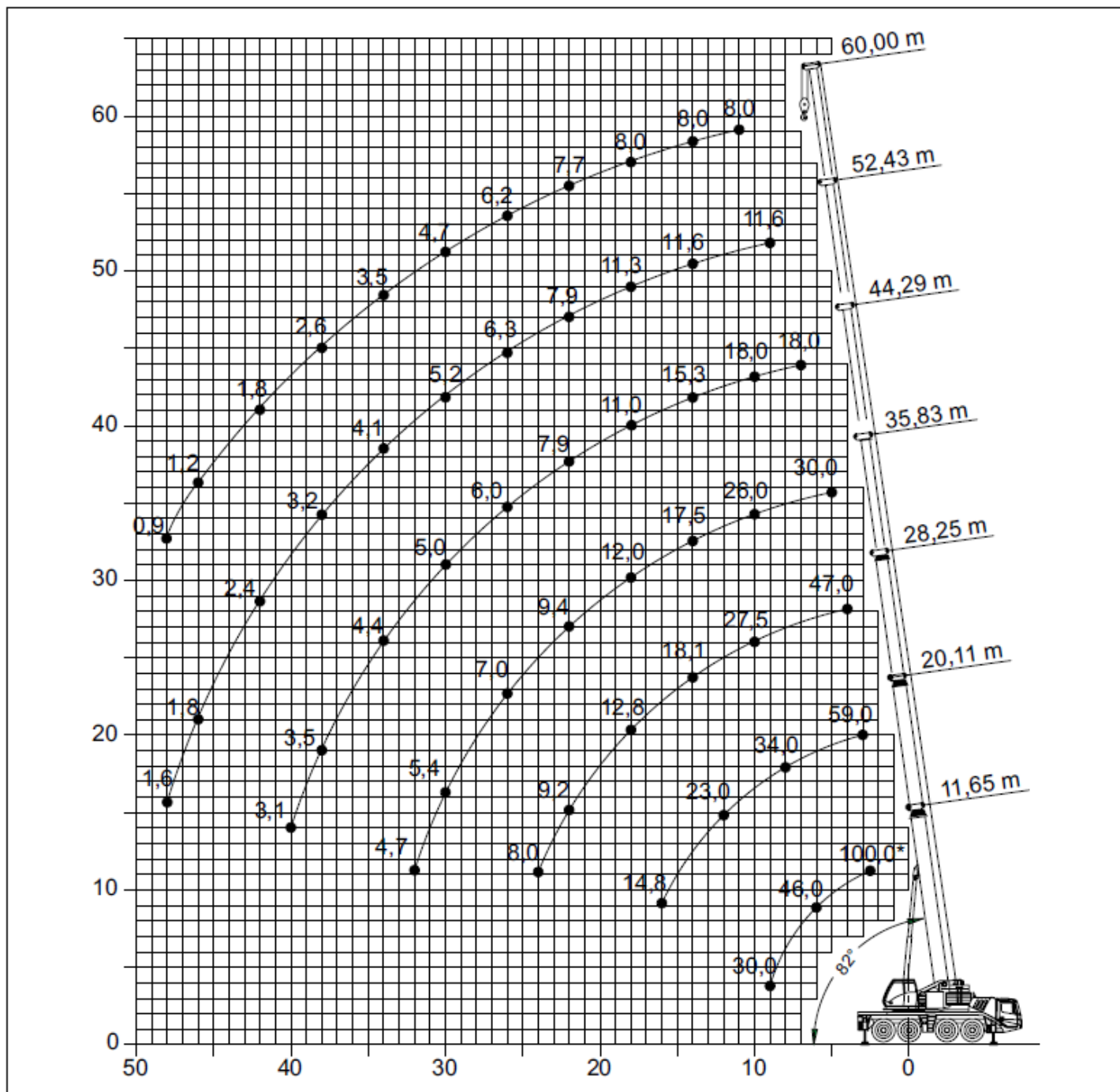

	Hook block • Hakenflasche • Crochet-moufle • Gancho • Ganci • Крюковой блок (t)	H (mm)
	100 D	3100
	63 E/D	3000
	40 E/D	2900
	20 E/D	2800
	8 H/B	2350

Dimensions • Abmessungen • Encombrement
Dimensiones • Dimensioni • Размеры

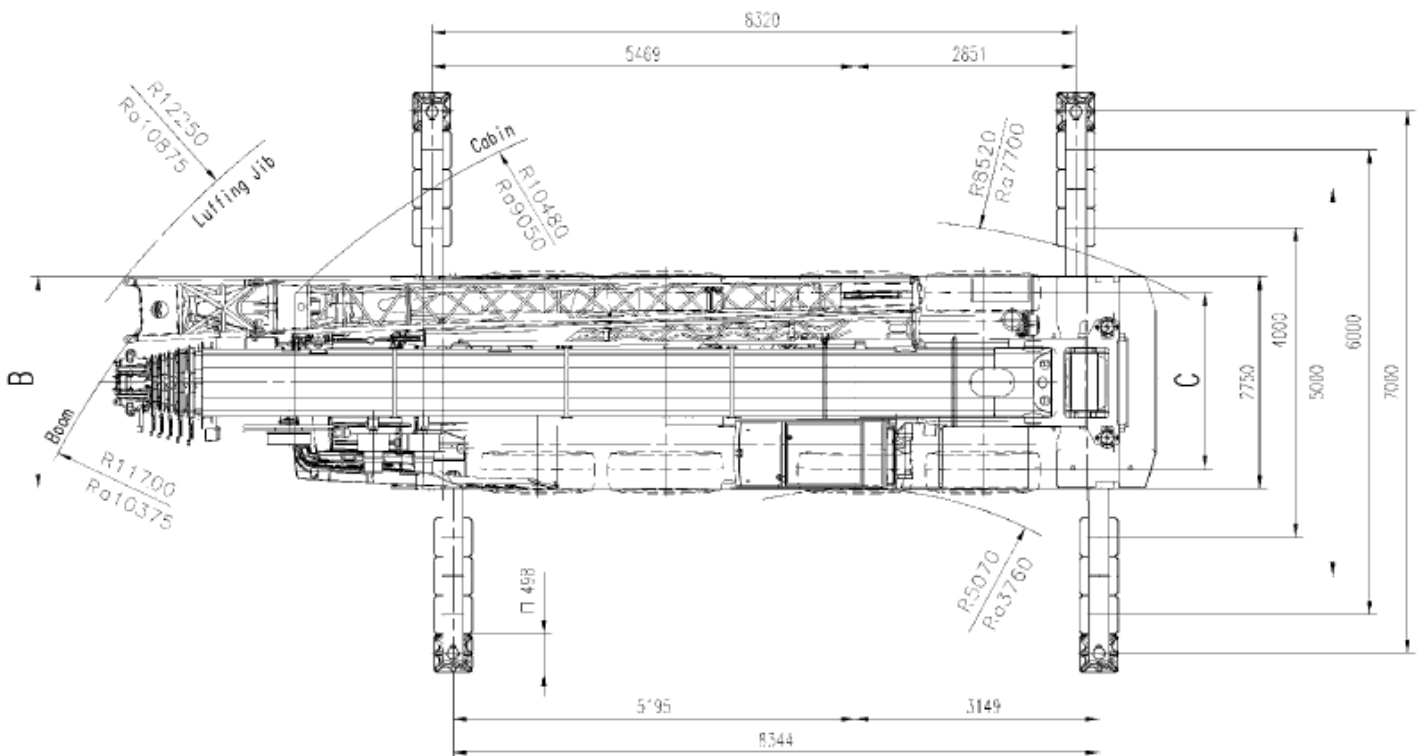
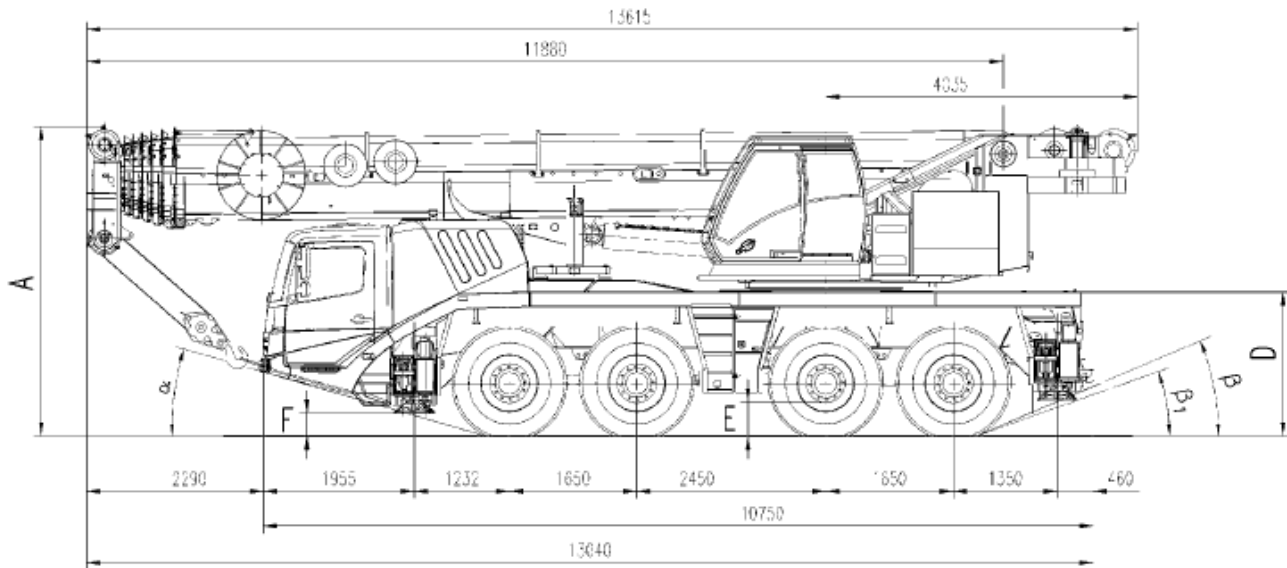

	A	A 130 mm*	B	C	D	E	F	α	β	β_1
14.00 R25	3940	3810	2750	2320	1750	435	262	14	21	17
16.00 R25	3990	3860	2750	2280	1863	485	292	16	23	19
20.5 R25	3990	3860	2880	2320	1863	485	292	16	23	19

* Lowered
Abgesenkt
Surbaisée
Abbassato
Rebaja
Сниженный